

TECKENFÖRKLARING

KÖRDNATSYSTEM: SWEREF 99 16 30
HÖJDSYSTEM: RH 2000

- DAGVATTENLEDNINGAR
- SPILLVATTENLEDNINGAR
- VATTENLEDNINGAR
- ELLEDNINGAR
- FJÄRRVÄRMELEDNINGAR
- TELELEDNINGAR -SKANOVA
- TELELEDNINGAR-TELE2

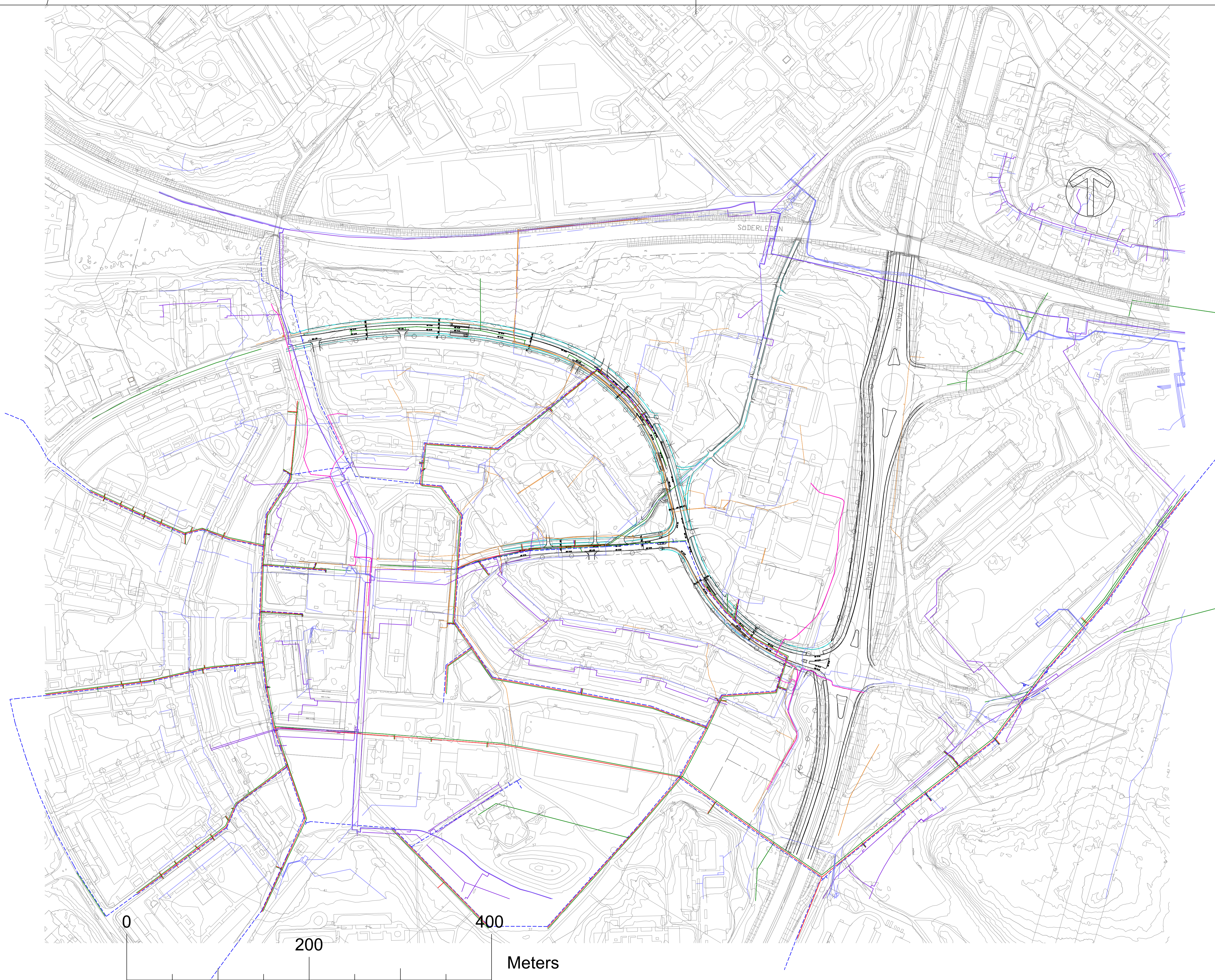

BET	ANT	ÄNDRINGEN AVSER	DATUM	SIDN

FÖRPROJEKTERING

Ramboll Sverige AB
HÖLMENGATAN 8
602 32 NORRKÖPING
Tfn: 010-65 00 00
Fax: 011-23 79 99
www.ramboll.se



PROJEKTNUMMER 1320027191	RITAD/ANSVARS H.SNÖBERG	ANSVARS H.SNÖBERG
-----------------------------	----------------------------	----------------------

2018-02-28 J. GRÄNDER

FÖRPROJEKTERING VILBERGEN

BEFINTLIGA LEDNINGAR

SKALA	NUMMER	BET
1:2000	L.01-001	

TECKENFÖRKLARING

KOORDINATSYSTEM: SWEREF 99 16 30

HÖJDSYSTEM: RH 2000

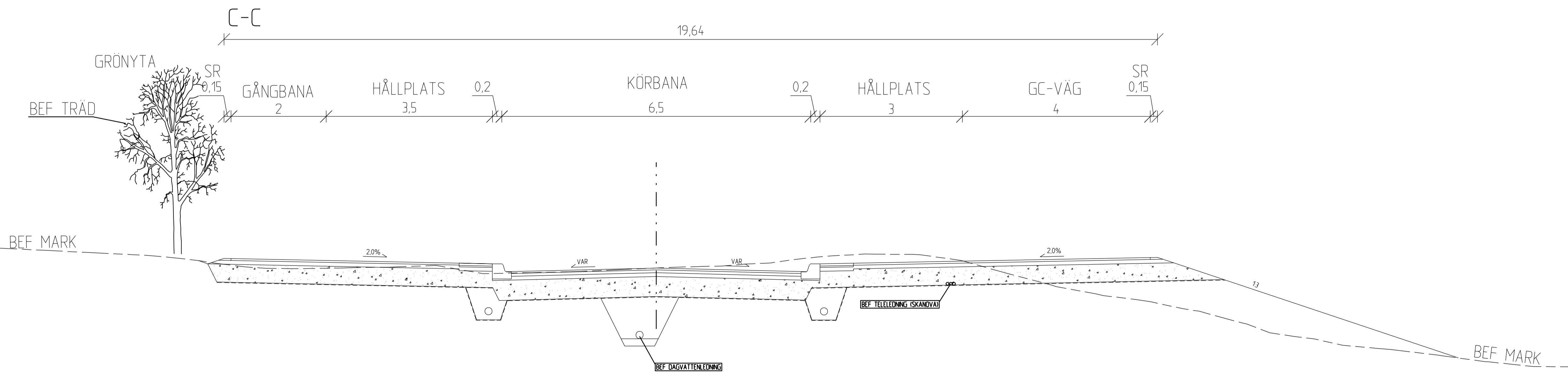
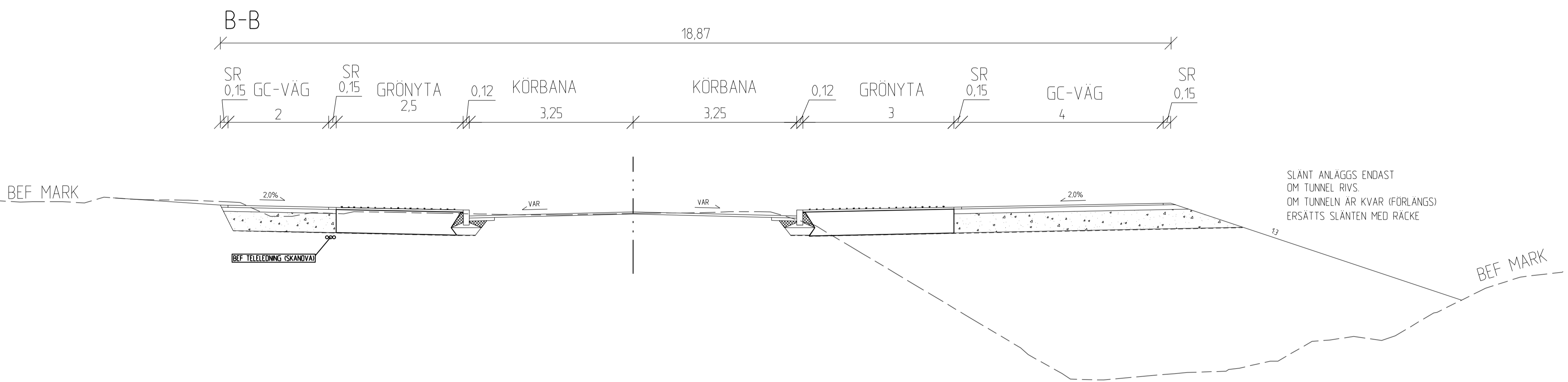
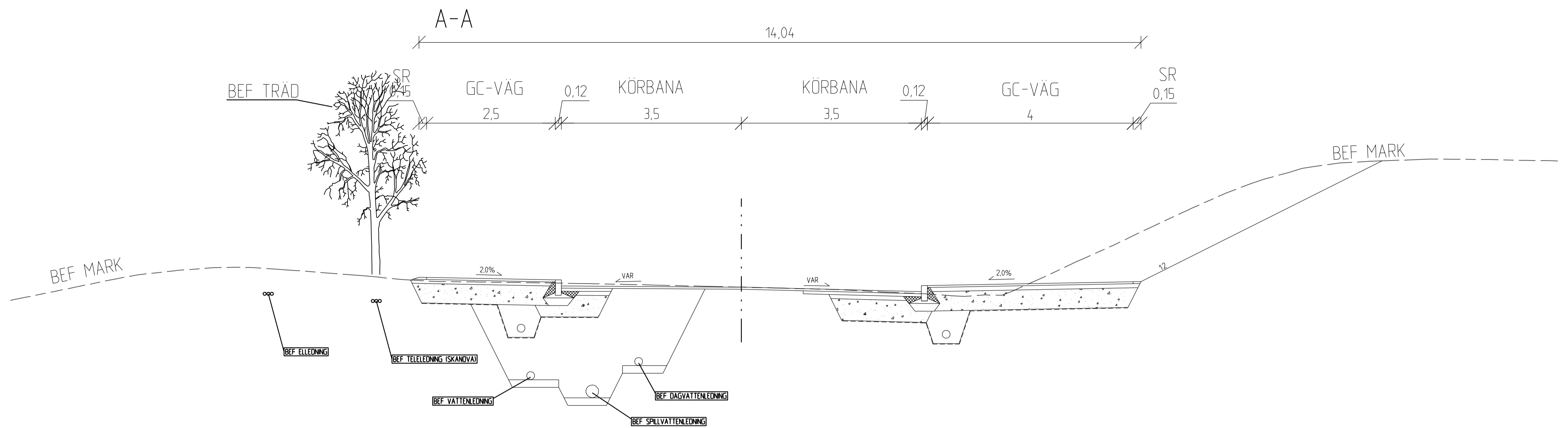

BET	ANT	ÄNDRINGEN AVSER	DATUM	SIGN

FÖRPROJEKTERING

Ramboll Sverige AB
 HJÄLMGATAN 8
 602 32 NORRKÖPING
 Tfn: 010-615 00 00
 Fax: 011-23 79 99
 www.ramboll.se



UPDRAG NR 1320027191	RITAD/KONSTR AV HSNOBERG	HÄNSKÄRBT HSNOBERG
DATUM 2018-02-28	ANSVARIG J. GRANDE	

FÖRPROJEKTERING VILBERGEN
 NORMALSEKTIONER MED BEFINTLIGA LEDNINGAR

SKALA 1:50	NUMMER N.04-001	BET
---------------	--------------------	-----

TECKENFÖRKLARING

KOORDINATSYSTEM: SWEREF 99 16 30

HÖJDSYSTEM: RH 2000

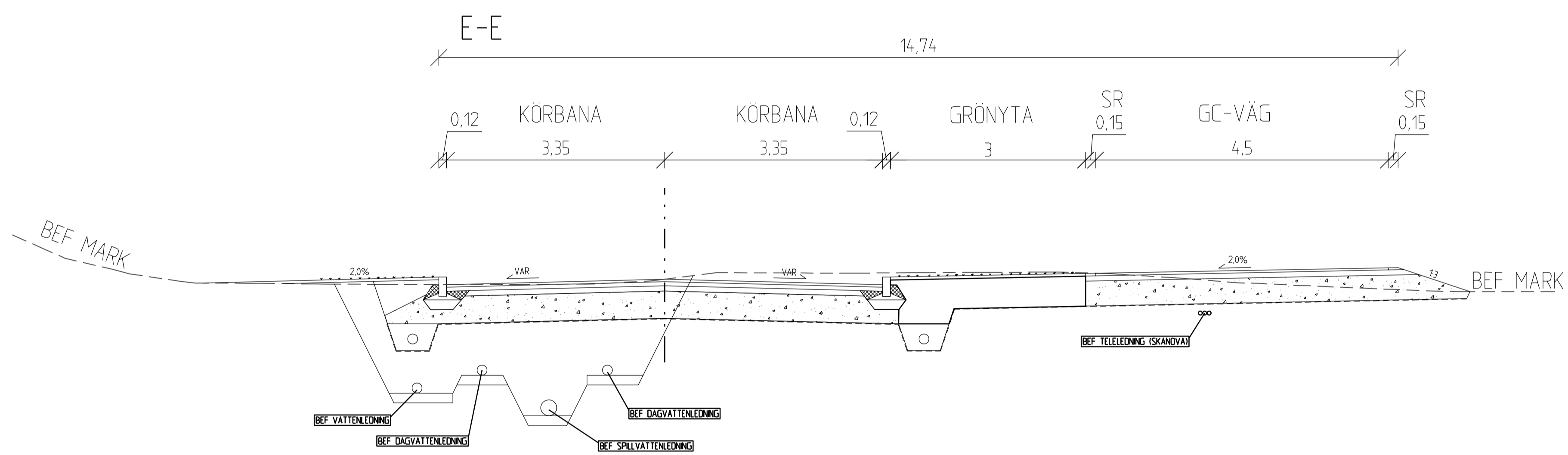
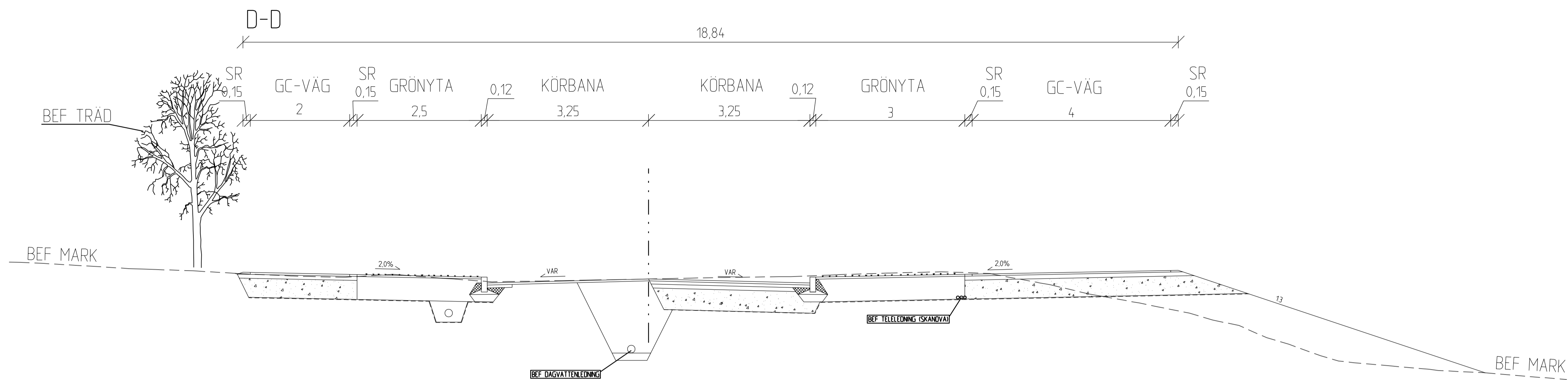

BET	ANT	ÄNDRINGEN AVSER	DATUM	SIGN

FÖRPROJEKTERING

Ramboll Sverige AB
 HJULMENGATAN 8
 602 32 NORRKÖPING
 Tfn: 010-615 00 00
 Fax: 011-23 79 99
www.ramboll.se



PROJEKT NR 1320027191	RITAD/KONSTR AV HSNOBERG	HAJN/SCHEFF HSNOBERG
DATUM 2018-02-28	ANSVARIG J. GRANDE	

FÖRPROJEKTERING VILBERGEN

NORMALSEKTIONER MED BEFINTLIGA LEDNINGAR

SKALA 1:50	NUMMER N.03-001	BET
---------------	--------------------	-----

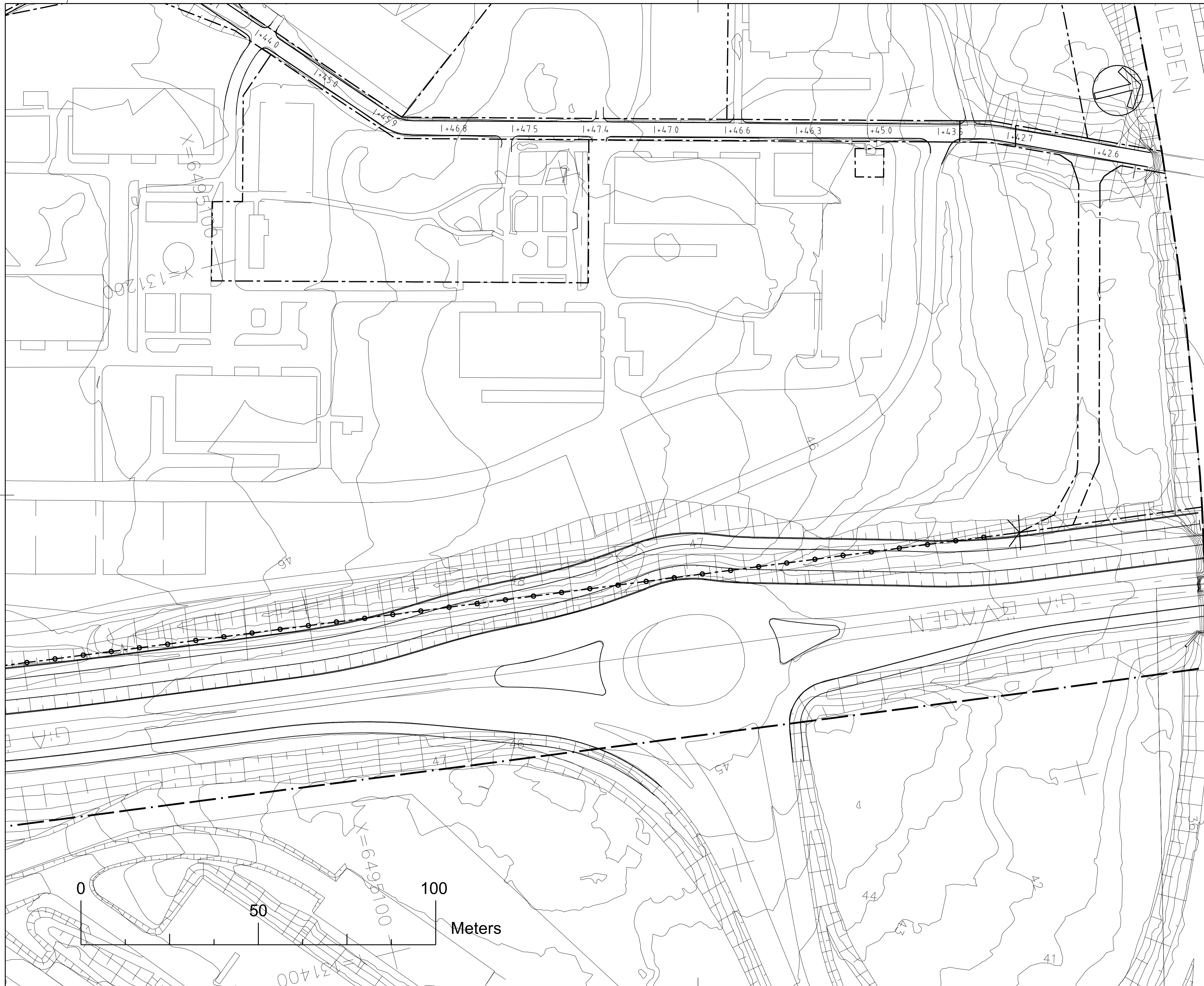

TECKENFÖRKLARING
 KOORDINATSYSTEM: SWEREF 991630
 HÖJDSYSTEM: RH 2000

BET	ANT	ÄNDRINGEN AVSER	DATUM	SIGN

FÖRPROJEKTERING

Ramboll Sverige AB
 HELMENGATAN 8
 602 32 NORRKÖPING
 Tfn: 010-615 00 00
 Fax: 011-23 79 99
www.ramboll.se

RAMBOLL

PROJEKT NR: 1320027191
 RITAD/KONSTR AV: H.SNOBERG
 HANRÄSKRIBER: H.SNOBERG
 DATUM: 2018-02-28
 ANSVARIG: J. GRÄNDER
 FÖRPROJEKTERING VILBERGEN

MARKPLAN 1

SKALA: 1:500
 NUMMER: T.02-001
 BET:

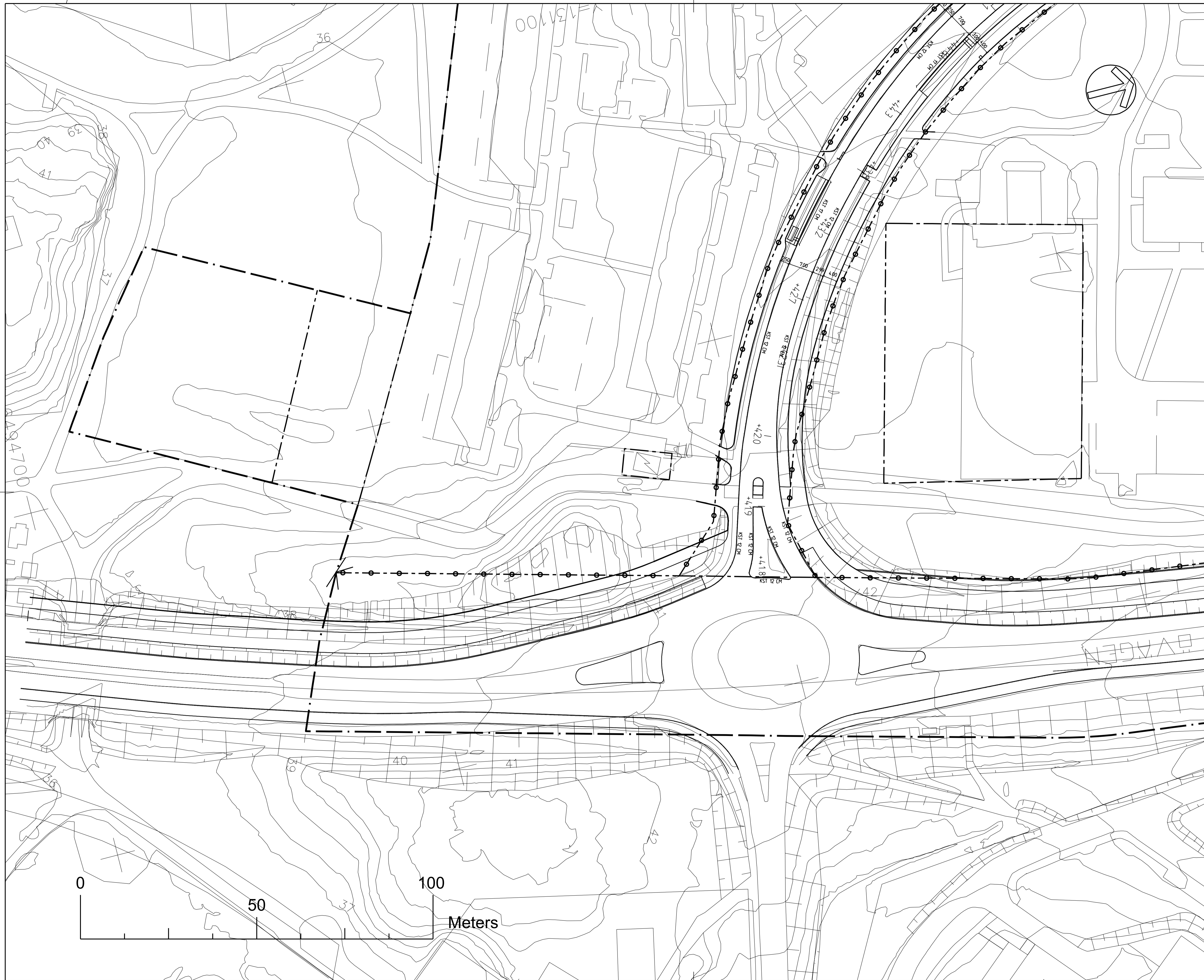

TECKENFÖRKLARING
 KOORDINATSYSTEM: SWREF 991630
 HÖJDSYSTEM: RH 2000

BET	ANT	ÄNDRINGEN AVSER	DATUM	SIGN
		FÖRPROJEKTERING		

Ramboll Sverige AB
 HELMENGATAN 8
 602 32 NORRKÖPING
 Tfn: 010-615 00 00
 Fax: 011-23 79 99
www.ramboll.se





UPDRAGS NR: 1320027191
 RITAD/KONSTR AV: H.SNOBERG
 HANRÄSKAVAR: H.SNOBERG
 DATUM: 2018-02-28
 ANSVARIG: J. GRÄNDER

FÖRPROJEKTERING VILBERGEN

MARKPLAN 2
 SKALA: 1:500
 NUMMER: T.02-002
 BET:

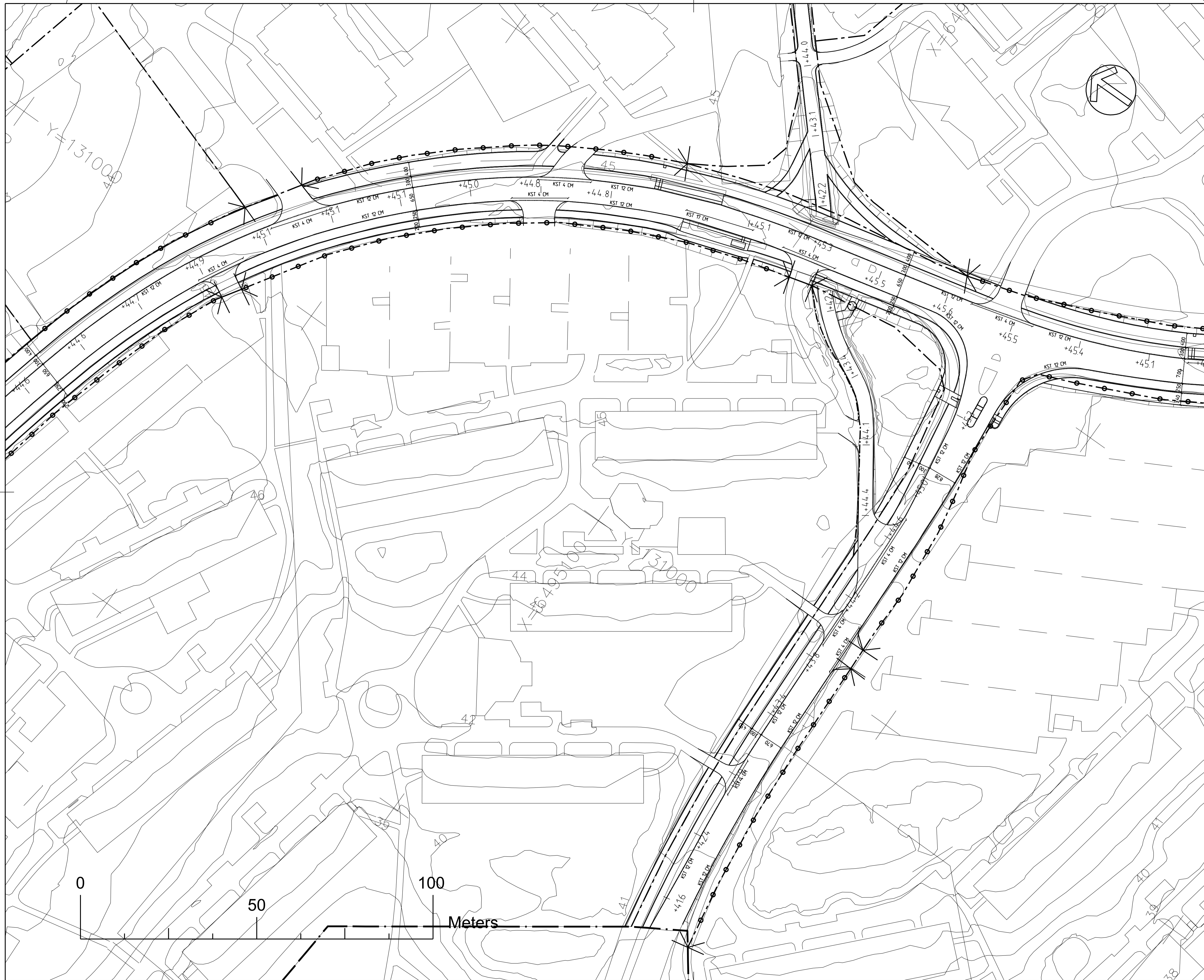
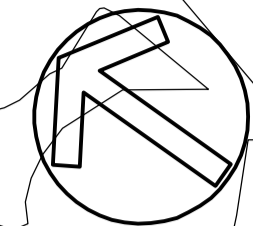
TECKENFÖRKLARING
 KOORDINATSYSTEM: SWEREF 991630
 HÖJDSYSTEM: RH 2000



BET	ANT	ÄNDRINGEN AVSER	DATUM	SIGN
FÖRPROJEKTERING				
Ramboll Sverige AB HJÄLMENGATAN 8 602 32 NORRKÖPING Tfn: 010-615 00 00 Fax: 011-23 79 99 www.ramboll.se				
UPPDRAGS NR: 1320027191	RITAD/KONSTR AV: HSNOBERG	HANRÄSKRIBET: HSNOBERG		
DATUM: 2018-02-28	ANSVARIG: J. GRANDEL			
FÖRPROJEKTERING VILBERGEN				
MARKPLAN 3				
SKALA: 1:500	NUMMER: T.02-003	BET:		

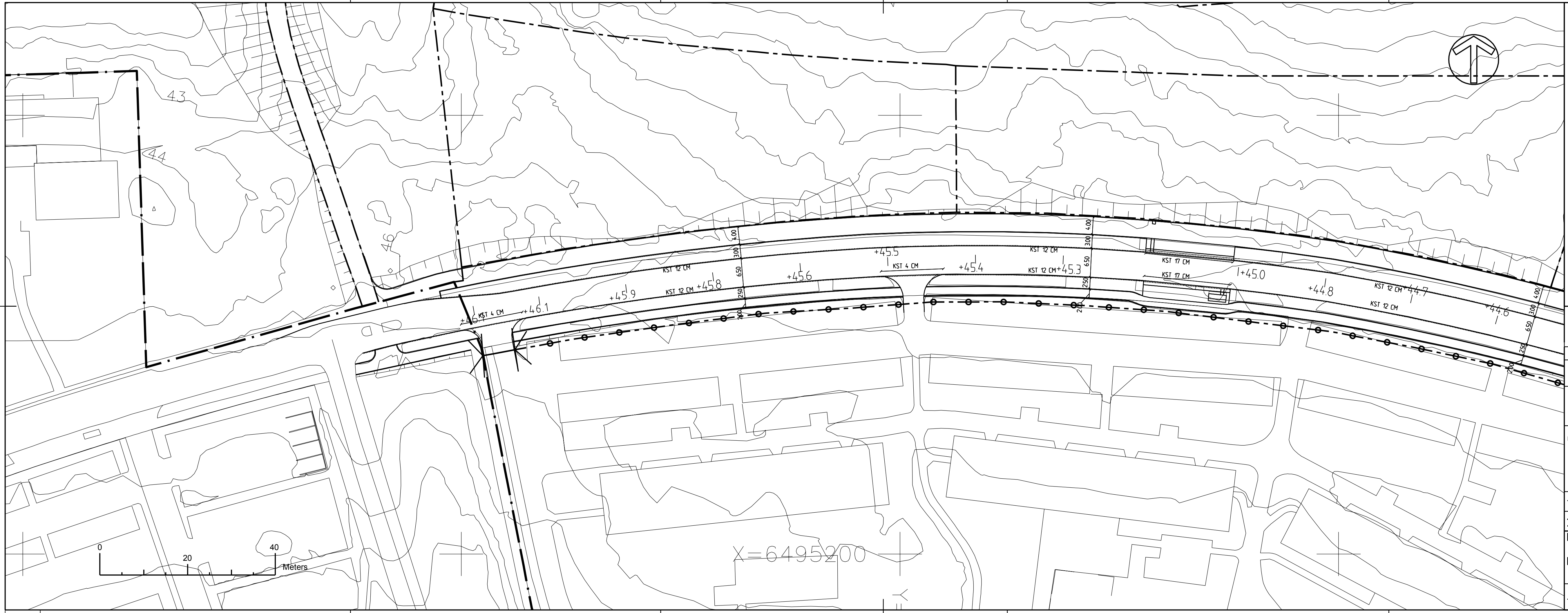

TECKENFÖRKLARING

KOORDINATSYSTEM: SWEREF 991630
HÖJDSYSTEM: RH 2000

BET	ANT	ÄNDRINGEN AVSER	DATUM	SIGN

FÖRPROJEKTERING

Ramboll Sverige AB
HOLMENGATAN 8
602 32 NORRKÖPING
Trn: 010-615 00 00
Fax: 011-23 79 99
www.ramboll.se



LIPPDRAG NR 1320027191	RITAD/KONSTR AV H.SNOBERG	HANDLÄGGARE H.SNOBERG
----------------------------------	-------------------------------------	---------------------------------

DATUM 2018-02-28	ANSVARIG J. GRANDER
----------------------------	-------------------------------

FÖRPROJEKTERING VILBERGEN

MARKPLAN 4

SKALA 1:500	NUMMER T.02-004	BET
-----------------------	---------------------------	-----

TECKENFÖRKLARING:
 KOORDINATSYSTEM SWEREF 99 16 30
 HÖJDSYSTEM RH 2000

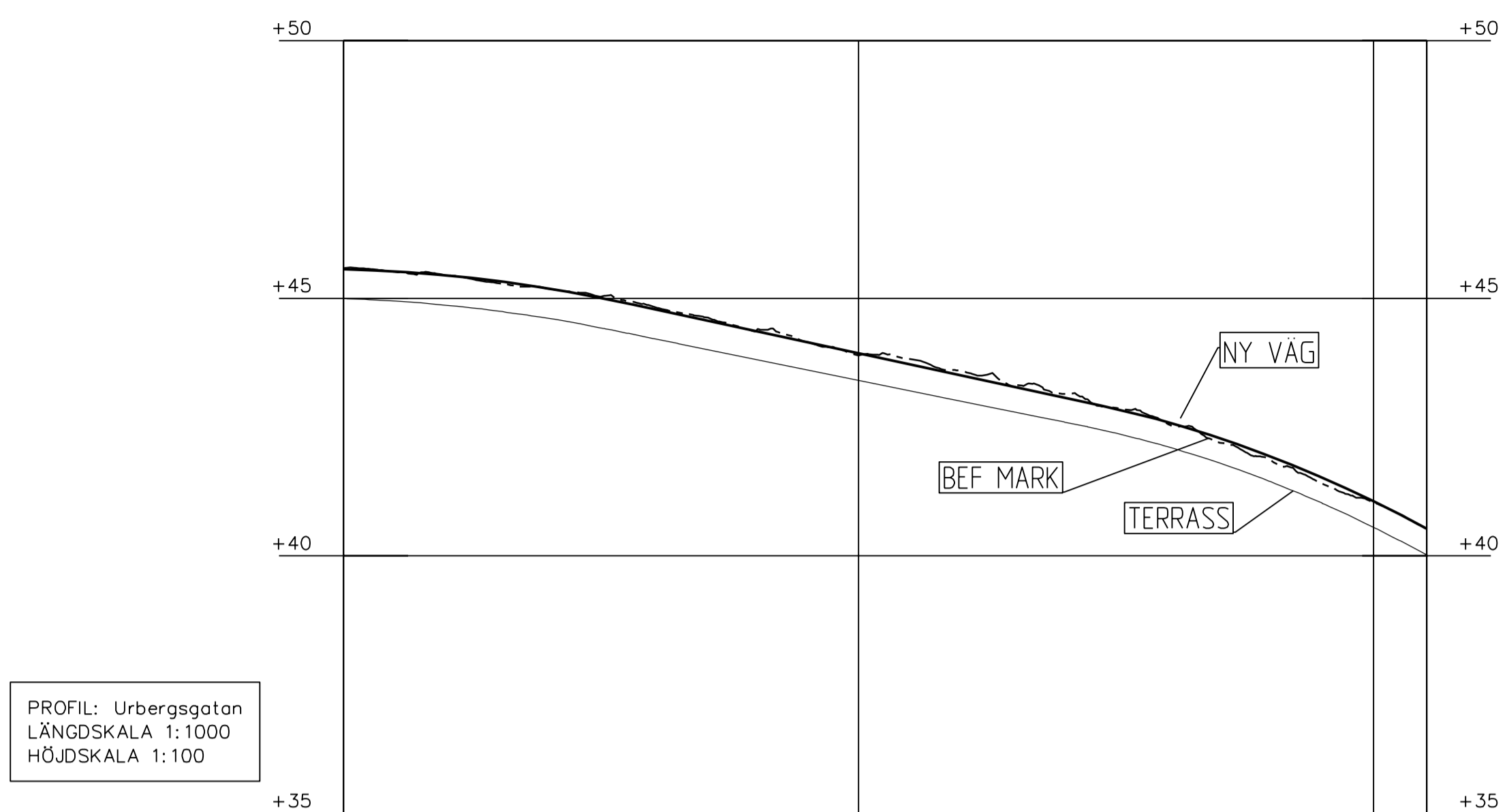

PROFIL: Urbergsgatan
 LÄNGDSKALA 1:1000
 HÖJDSKALA 1:100

PROFILDATA	-0.29%	RV 3000.83	-2.16%	RV 1949.47	-1.75%	RV 1949.47	-1.75%							
PROFILLINJE	45.44	45.19	44.80	44.36	43.93	43.50	43.07	42.59	41.93	41.06	39.98	38.75	37.79	37.26
LANGDMÄTNING	0/100													
PLANDATA	L 4.96	R 363.37	L 58.79	L 69.03	R 408.92	L 77.50								

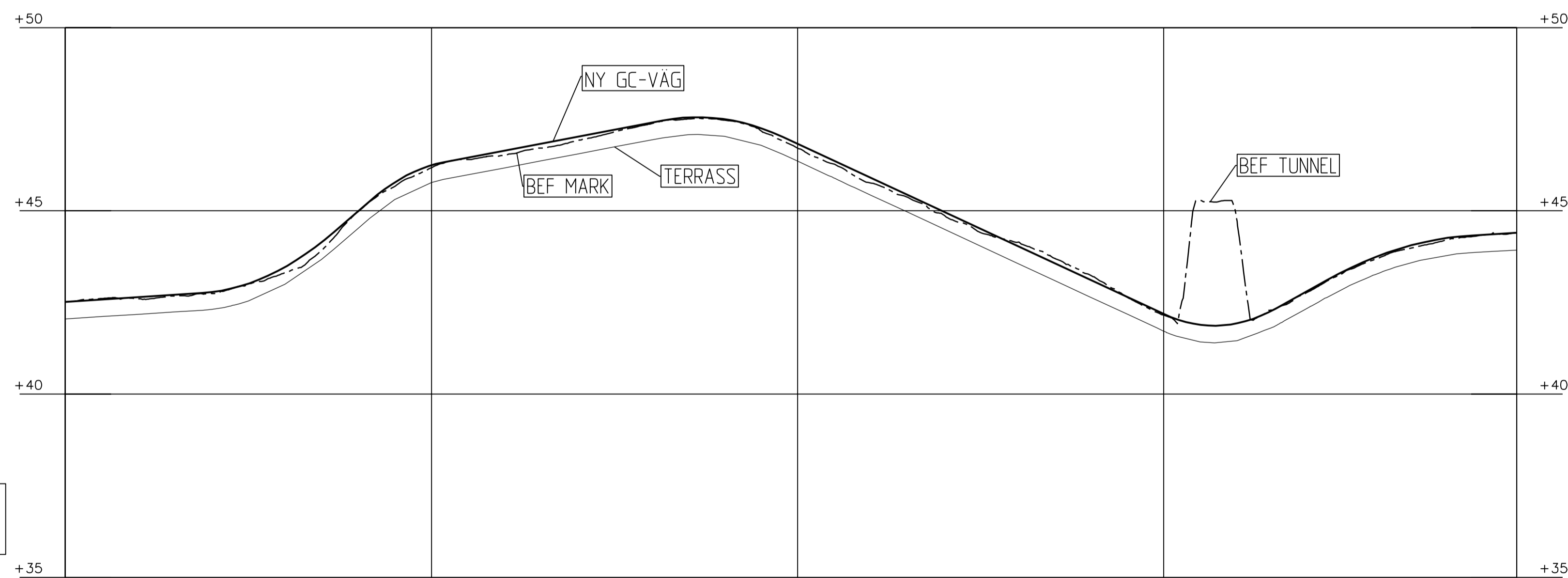

PROFIL: GC-väg
 LÄNGDSKALA 1:1000
 HÖJDSKALA 1:100

PROFILDATA	0.64%	RV 450.00	0.64%	RV 300.00	1.90%	RV 500.00	-4.64%	RV 300.00	5.57%	RV 800.00	0.59%								
PROFILLINJE	42.65	42.78	43.47	44.99	46.25	46.64	47.02	47.40	47.50	46.83	45.90	44.97	44.04	43.12	42.19	41.93	42.86	43.82	44.29
LANGDMÄTNING	0/100																		
PLANDATA	L 43.36	R 25.00	L 4.22	L 160.91	R 12.00	L 7.02	L 82.69	R 50.00	L 16.64	R 50.00	L 6.81	L 25.00	L 33.18						

BET ANT SNDRINGEN AVSER DATUM SIGN
FÖRPROJEKTERING

Ramboll Sverige AB
 HELMENGATAN 8
 602 32 NORRKPING
 Tfn: 010-615 00 00
 Fax: 011-23 79 99
 www.ramboll.se



PROJEKT NR: 1320027191
 RITAD/KONSTR AV: HSNOBERG
 HANS SVENSSON
 ANSVARIG: HSNOBERG
 J. GRANDE

DATUM: 2018-02-28
 FÖRPROJEKTERING VILBERGEN
 PROFIL URBERGSGATAN OCH GC-VÄG

SKALA: 1:1000
 NUMMER: P.01-002
 BET:

TECKENFÖRKLARING:

KOORDINATSYSTEM SWREF 99 16 30
HÖJDSYSTEM RH 2000

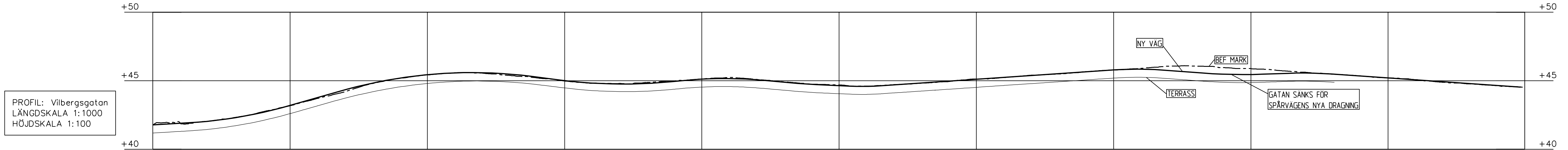

PROFIL: Vilbergsgatan
LÄNGDSKALA 1:1000
HÖJDSKALA 1:100

PROFILDATA	0.59%	RV 3300.00	2.87%	RV 3403.13	-1.27%	RV 3600.00	0.98%	RV 3200.00	-0.89%	RV 3000.00	-0.47%	2000.00	0.68%	RV 2500.00	-0.74%	RV 4000.00	0.35%	V 3000.00	-0.69%																														
PROFILLINJE	41.90	42.05	42.31	42.70	43.20	43.77	44.34	44.83	45.19	45.44	45.58	45.59	45.49	45.27	45.02	44.83	44.76	44.80	44.96	45.12	45.16	45.07	44.90	44.74	44.65	44.60	44.71	44.84	44.98	45.11	45.25	45.38	45.52	45.65	45.79	45.85	45.75	45.60	45.48	45.46	45.52	45.56	45.48	45.34	45.21	45.07	44.93	44.79	44.65
LANGDMÄTNING	0/100			0/200			0/300			0/400			0/500			0/600			0/700			0/800			0/900																								
PLANDATA	L 19.75				L 42.13	L 19.44	L 18.91		R 210.08			L 68.05			R 517.12			L 50.57			R 400.00			L 10.66	R 400.00	L 32.75	R 400.00	L 32.67	R 400.00	L 42.27					R 38.86		L 28.46		L 42.35		L 17.44								

BET	ANT	ÄNDRINGEN AVSER	DATUM	SIGN
-----	-----	-----------------	-------	------

FÖRPROJEKTERING

Ramböll Sverige AB
HOLMENGATAN 8
602 32 NORRKÖPING
Tfn: 010-615 00 00
Fax: 011-23 79 99
www.ramboll.se



UPPDRAG NR 1320027191	RITAD/KONSTR AV H.SNOBERG	HANDLÄGGARE H.SNOBERG
--------------------------	------------------------------	--------------------------

DATUM 2018-02-28	ANSVARIG J. GRANDER
---------------------	------------------------

FÖRPROJEKTERING VILBERGEN

PROFIL VILBERGSGATAN

SKALA 1:1000	NUMMER P.01-001	BET
-----------------	--------------------	-----

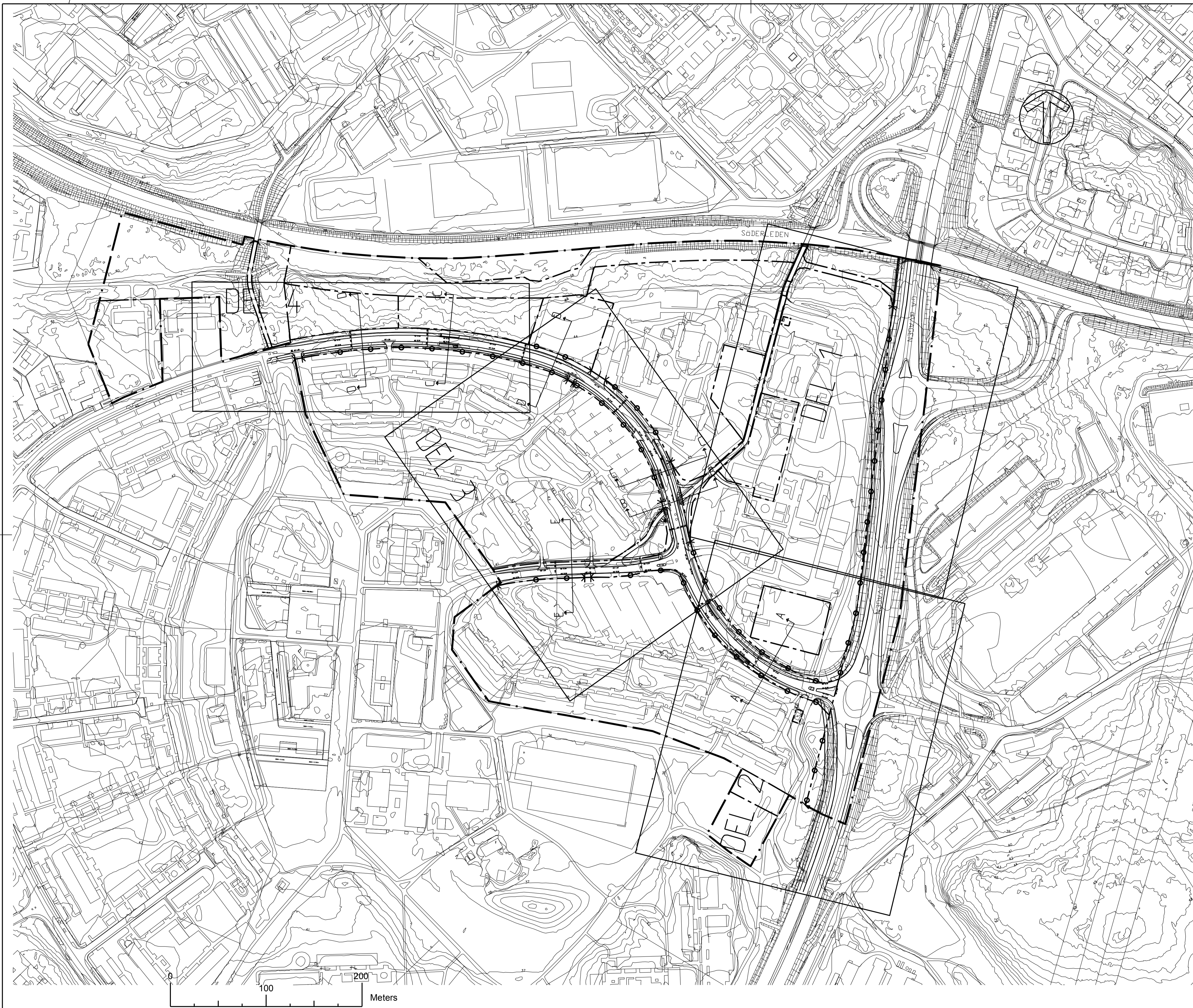

TECKENFÖRKLARING

KOORDINATSYSTEM: SWEREF 99 16 30
HÖJDSYSTEM: RH 2000

BET	ANT	ÄNDRINGEN AVSER	DATUM	SIGN
FÖRPROJEKTERING				

Ramboll Sverige AB
HÖLMENGATAN 8
602 32 NORRKÖPING
Tfn: 010-615 00 00
Fax: 011-23 79 99
www.ramboll.se



PROJEKT NR 1320027191	RITAD/KONSTR AV H.SNOBERG	HAJN/ANSVÄRIG H.SNOBERG
DATUM 2018-02-28	ANSVÄRIG J. GRÄNDER	

FÖRPROJEKTERING VILBERGEN

ÖVERSIKTSPLAN

SKALA 1:2000	NUMMER M.01-001	BET
-----------------	--------------------	-----